

**Actividad 1:** Para los siguientes objetos, indica el **rectángulo de encaje más proporcionado** en cada caso de entre los que se ofrecen.

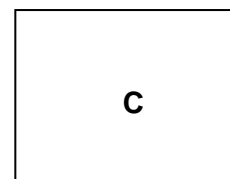

**Actividad 2:** Para los siguientes objetos, dibuja en una hoja aparte un **rectángulo de encaje proporcionado**, pero a un tamaño doble de grande.

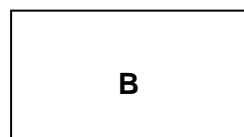
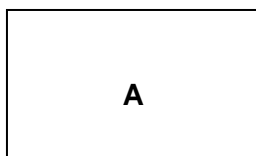
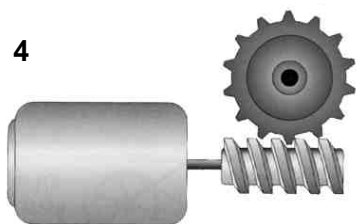
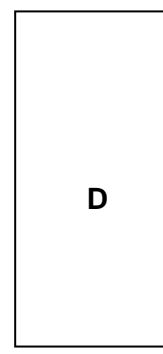
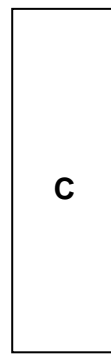
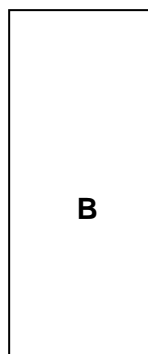
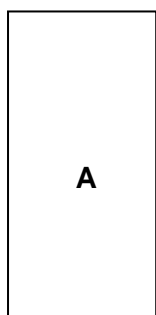
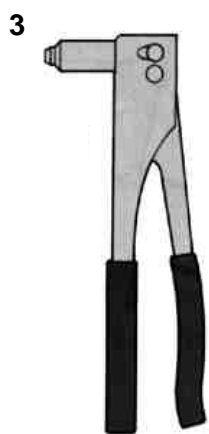
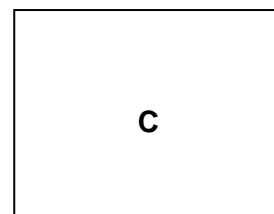
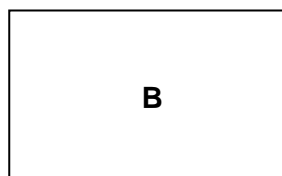
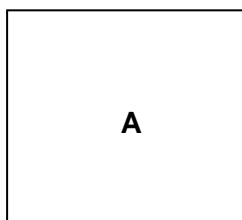
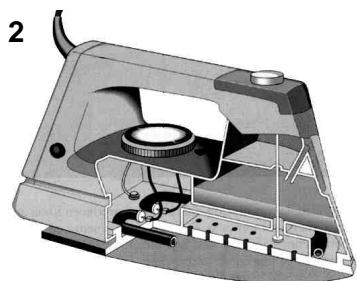
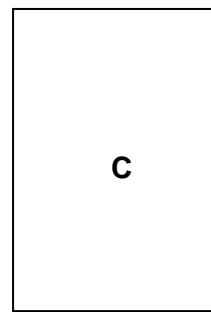
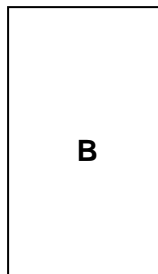
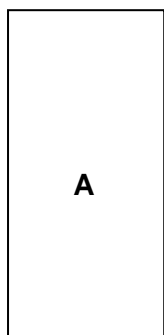
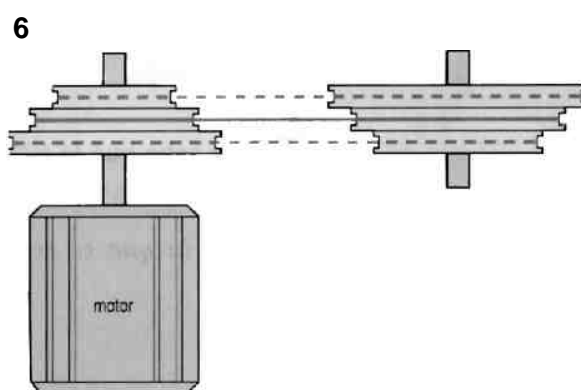
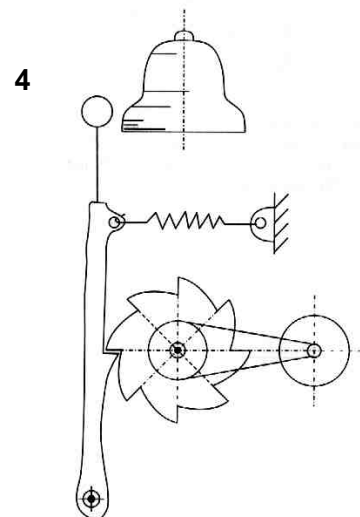
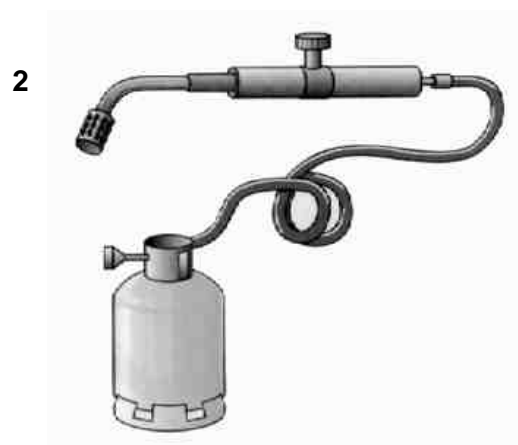
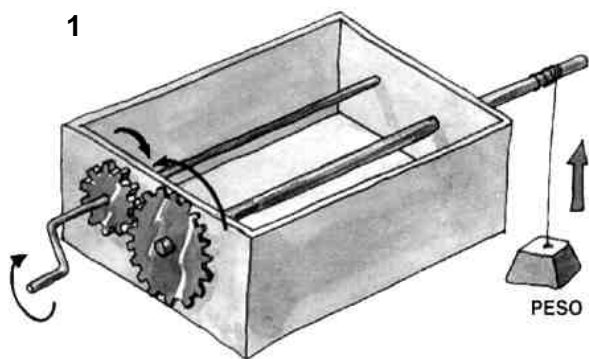

**Actividad 3:** Indica todos los **ejes de simetría**, totales y parciales, que observes en las siguientes figuras y que podrían ser útiles para dibujarla a mano alzada.

a)

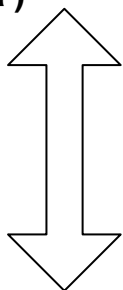

b)

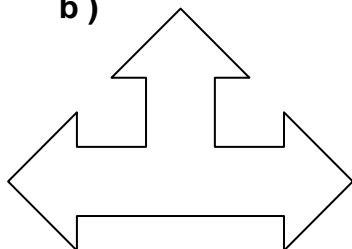

c)

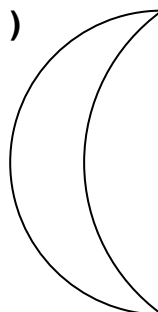

d)

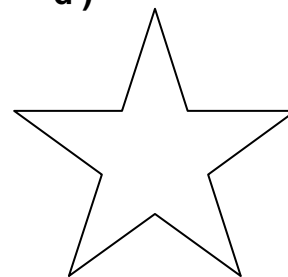

e)



f)

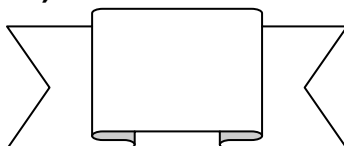

g)

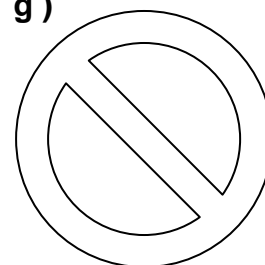

h)

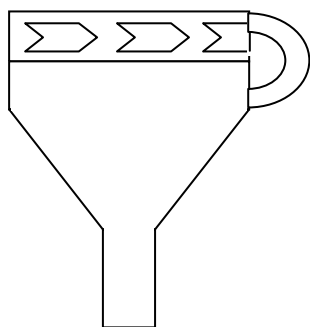

i)

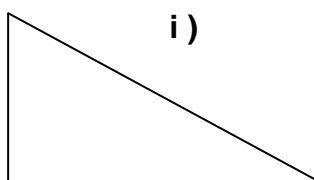

j)

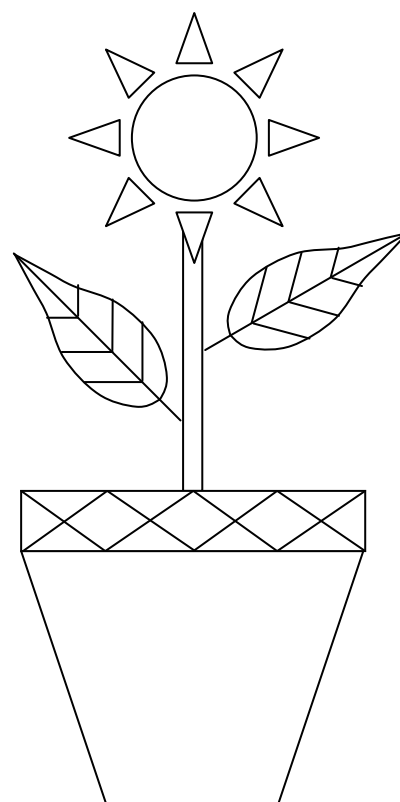

k)



**Actividad 4:** Detecta y traza todos los **ejes de simetría** que observes en las figuras siguientes. Estos ejes pueden ser tanto de la figura completa como de partes de la misma. Trázalos también sobre los rectángulos de encaje que realizaste en una actividad anterior.

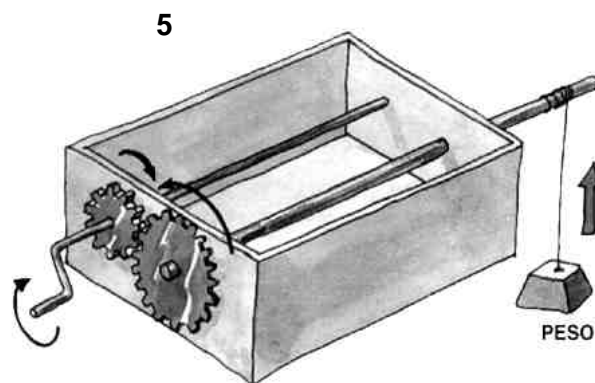
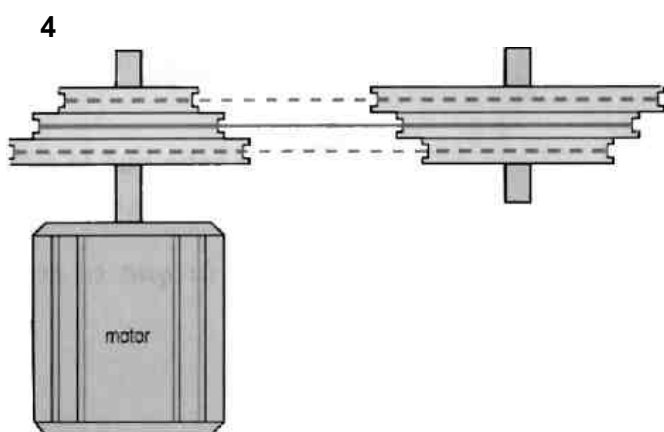
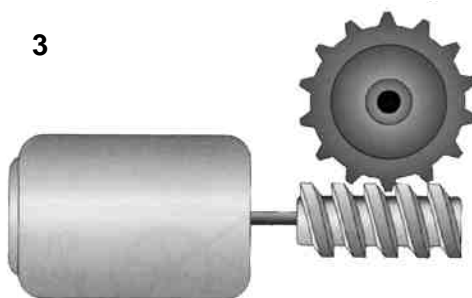

**Actividad 5:** Trata de detectar **formas geométricas básicas** en las siguientes figuras y situálas en el rectángulo de encaje que hemos realizado en las actividades anteriores. Observa lo que hemos hecho en la figura que se presenta como ejemplo.



Ejemplo →

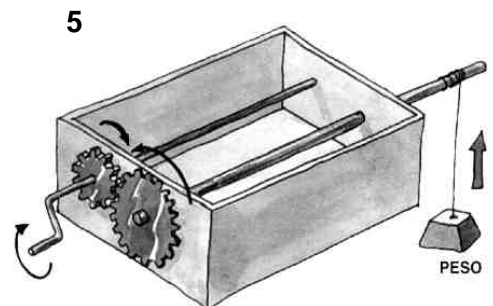
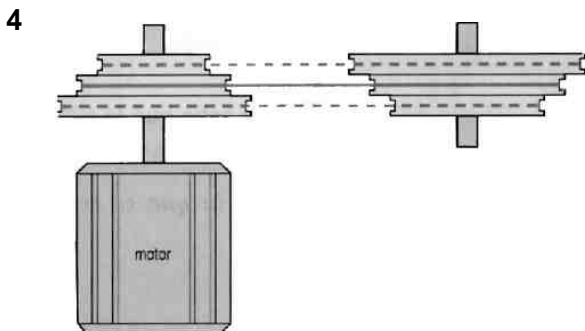
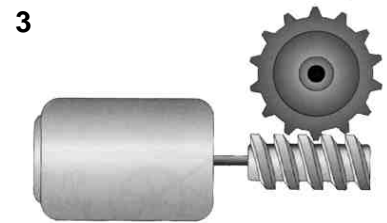
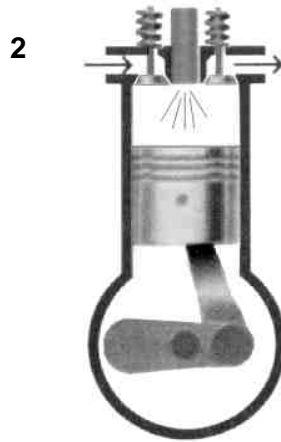
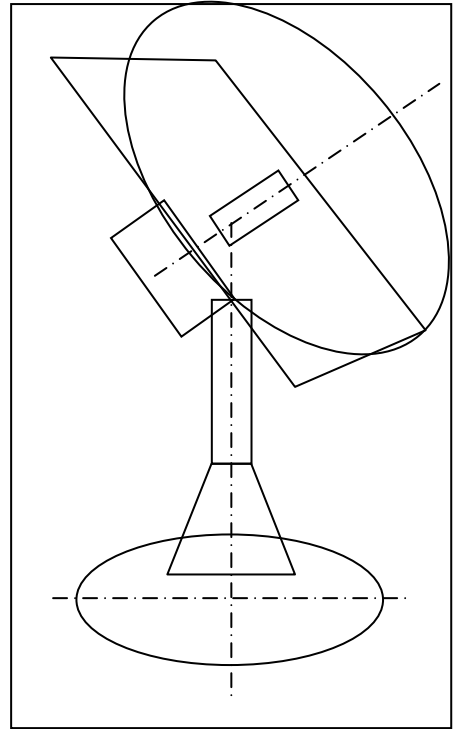

**Actividad 6:** Completa a mano alzada los siguientes dibujos teniendo en cuenta los ejes de simetría.

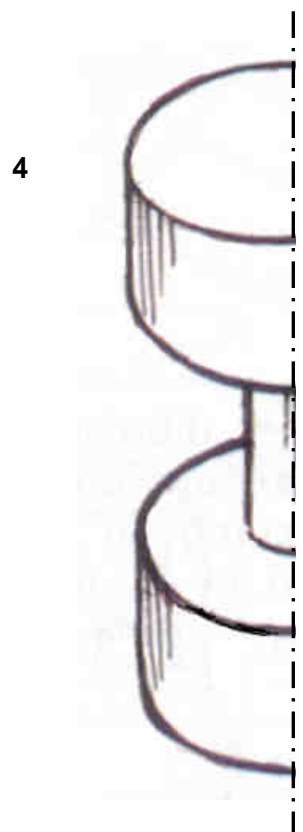
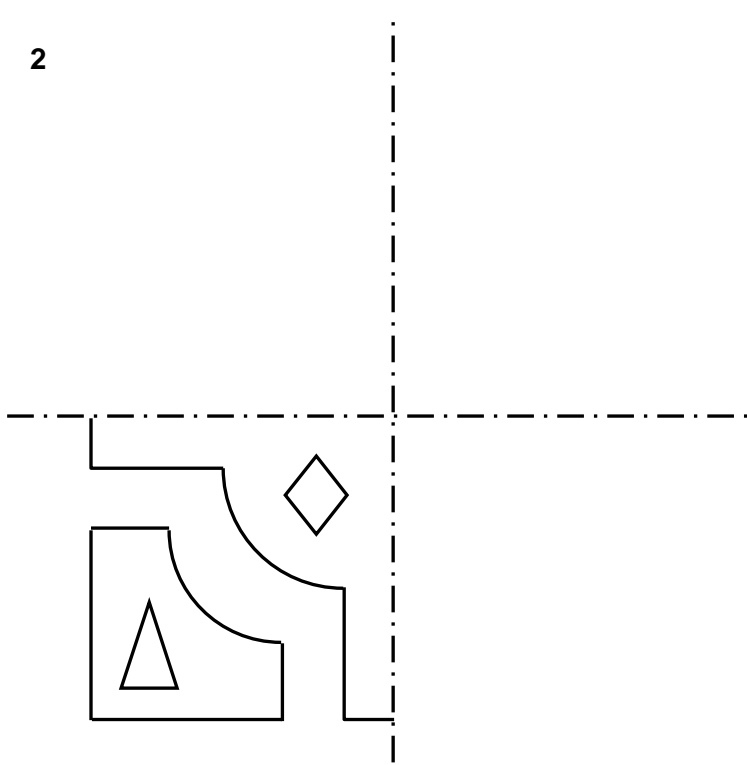
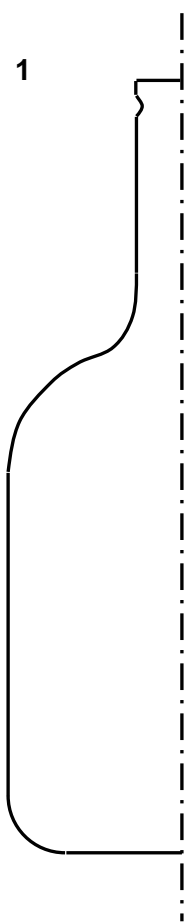

5

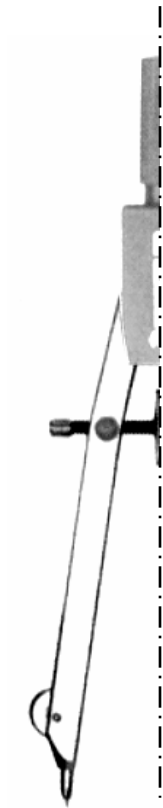

6



7



